

Article number: 01010551
 Description: Retaining ring A 38 DIN 471
 Stainless 411
 Note: Fitted with ZGA pilers

Measures

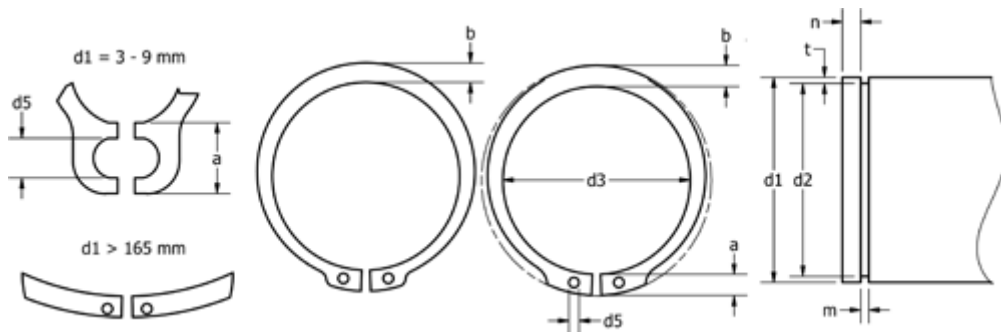

a max	= 5.8	FN kN	= 19.3	s	= 1.75
AN mm ²	= 116.0	FRg kN	= 9.10	t	= 1.00
b	= 4.2	FR kN	= 49.50	tol	= -0.25
d1	= 38	g	= 2.0	tol	= -0.06
d2	= 36.0	K kN-mm	= 95.00	tol	= +0,25-0,50
d3	= 35.2	m min	= 1.85	Tong	= ZGA-2
d5 min	= 2.5	n abl x 1000	= 14.0	Weight kg/1000	= 5.620
Description	= A38	Nominal drive	= 3.0		